

Economical single display type, PID control

■ Features

- Realizes ideal temp. controlling with newly developed PID control algorithm and 100ms high speed sampling
- **Built-in relay output or SSR output selectable**
: Enables to phase control and cycle control with SSR drive output(SSRP function)
- Dramatically increased visibility using wide display part
- Mounting space saving with compact design
: Approx. 38% reduced size compared with existing model(depth-based)
- SV/PV deviation indicatable

Upgrade



⚠ Please read "Caution for your safety" in operation manual before using.



■ Ordering information

T C 4 S - 1 4 R

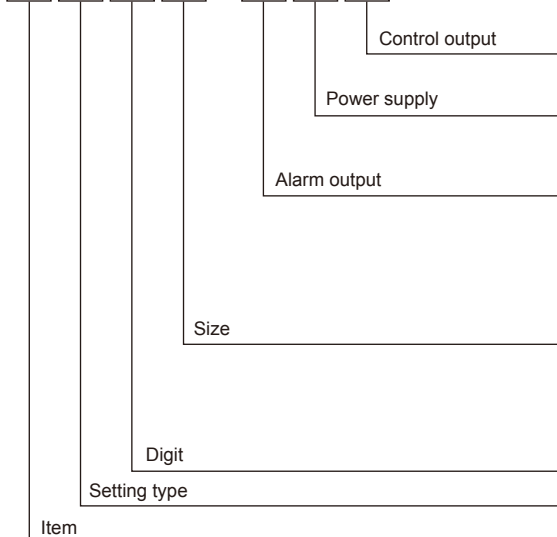

N	Indicator - Without control output
R	Relay output + SSRP output (AC power) Relay output + SSR output (AC/DC power)
2	24-48VDC, 24VAC 50/60Hz
4	100-240VAC 50/60Hz
N	No alarm output
1	Alarm1 output
2	Alarm1 output + Alarm2 output ^{※1}
S	DIN W48×H48mm (Terminal block type)
SP	DIN W48×H48mm (11pin plug type) ^{※2}
Y	DIN W72×H36mm
M	DIN W72×H72mm
H	DIN W48×H96mm
W	DIN W96×H48mm
L	DIN W96×H96mm
4	9999 (4digit)
C	Set by touch switch
T	Temperature controller

※1. It is unavailable for TC4SP, TC4Y.

※2. 11pin socket(PG-11, PS-11) for TC4SP: sold separately.

■ Specifications

Series	TC4S	TC4SP	TC4Y	TC4M	TC4W	TC4H	TC4L
Power supply	AC power	100-240VAC 50/60Hz					
	AC/DC power	24VAC 50/60Hz, 24-48VDC					
Allowable voltage range	90 to 110% of rated voltage						
Power consumption	AC power	Max. 5VA(100-240VAC 50/60Hz)					
	AC/DC power	Max. 5VA(24VAC 50/60Hz), Max. 3W(24-48VDC)					
Display method	7Segment(red), Other display part(green, yellow, red) LED method						
Character size (W×H)	7.0×15.0mm	7.4×15.0mm	9.5×20.0mm	9.5×20.0mm	7.0×14.6mm	11.0×22.0mm	
Input type	RTD	DPT100Ω, Cu50Ω(allowable line resistance max. 5Ω per a wire)					
	Thermocouple	K(CA), J(IC), L(IC)					
Display accuracy ^{※1}	RTD	• At room temperature(23°C±5°C): (PV ±0.5% or ±1°C, select the higher one) ±1digit • Out of room temperature range: (PV ±0.5% or ±2°C, select the higher one) ±1digit					
	Thermocouple	※In case of TC4SP Series, ±1°C will be added.					

※1: Thermocouple L(IC) type, RTD Cu50Ω

• At room temperature (23°C ±5°C): (PV ±0.5% or ±3°C, select the higher one) ±1digit

• Out of room temperature range: (PV ±0.5% or ±4°C, select the higher one) ±1digit

In case of TC4SP Series, ±1°C will be added.

Economical PID Control

Specifications

Series	TC4S	TC4SP	TC4Y	TC4M	TC4W	TC4H	TC4L
Control output	Relay	250VAC 3A 1a					
Control output	SSR	12VDC \pm 2V 20mA Max.					
Sub output	AL1, AL2 relay output: 250VAC 1A 1a(※TC4SP, TC4Y have AL1 only.)						
Control method	ON/OFF and P, PI, PD, PID control						
Hysteresis	1 to 100°C/°F (0.1 to 50.0°C/°F) variable						
Proportional band (P)	0.1 to 999.9°C/°F						
Integral time (I)	0 to 9999 sec.						
Derivative time (D)	0 to 9999 sec.						
Control period (T)	0.5 to 120.0 sec.						
Manual reset	0.0 to 100.0%						
Sampling period	100ms						
Dielectric strength	AC power	2,000VAC 50/60Hz for 1min.(between input terminal and power terminal)					
	AC/DC power	1,000VAC 50/60Hz for 1min.(between input terminal and power terminal)					
Vibration	0.75mm amplitude at frequency of 5 to 55Hz(for 1 min.) in each of X, Y, Z directions for 2 hours						
Relay life cycle	Mechanical	OUT: Over 5,000,000 times, AL1/2: Over 5,000,000 times					
	Electrical	OUT: Over 200,000 times(250VAC 3A resistive load) AL1/2: Over 300,000 times(250VAC 1A resistive load)					
Insulation resistance	Min. 100M Ω (at 500VDC megger)						
Noise resistance	\pm 2kV R-phase, S-phase the square wave noise (pulse width: 1us) by the noise simulator						
Memory retention	Approx. 10 years (when using non-volatile semiconductor memory type)						
Environment	Ambient temperature	-10 to 50°C, storage: -20 to 60°C					
	Ambient humidity	35 to 85%RH, storage: 35 to 85%RH					
Insulation type	Double insulation or reinforced insulation (mark: \square), Dielectric strength between the measuring input part and the power part: AC power 2kV, AC/DC Power 1kV)						
Approval	CE c UL us (Except for AC/DC power type)						
Unit weight	Approx. 97g	Approx. 84g	Approx. 127g	Approx. 127g	Approx. 118g	Approx. 118g	Approx. 172g

※Environment resistance is rated at no freezing or condensation.

Connections

※TC4 Series has selectable control output; Relay output, and SSRP output. AC/DC power type has Relay output and SSR output and it is selectable.

TC4S

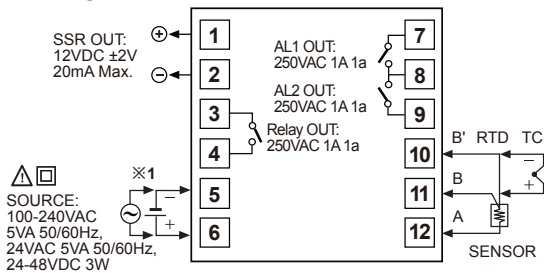

TC4SP

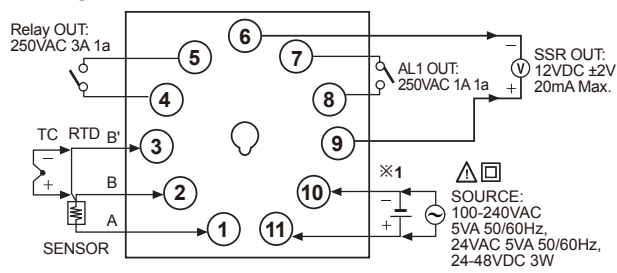

TC4Y

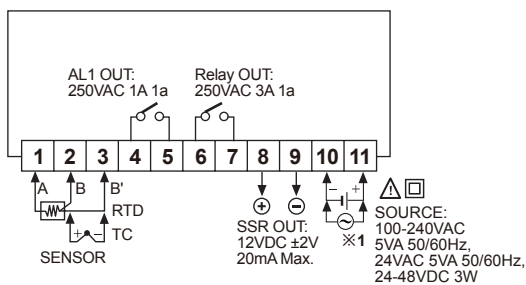

※1: • AC power: 100-240VAC 5VA 50/60Hz
• AC/DC power: 24VAC 5VA 50/60Hz, 24-48VDC 3W

TC4W

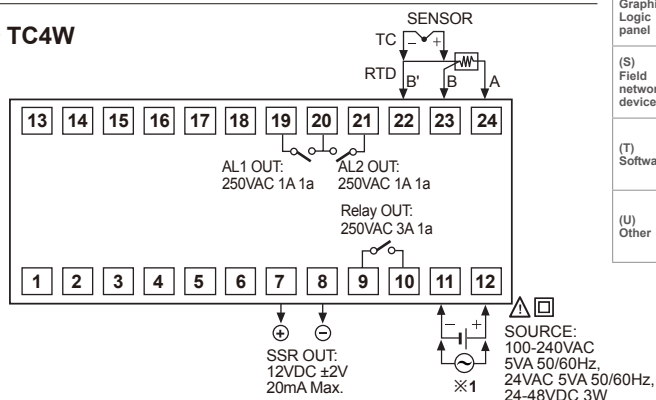

(A) Photo electric sensor

(B) Fiber optic sensor

(C) Door/Area sensor

(D) Proximity sensor

(E) Pressure sensor

(F) Rotary encoder

(G) Connector/Socket

(H) Temp. controller

(I) SSR/Power controller

(J) Counter

(K) Timer

(L) Panel meter

(M) Tacho/Speed/Pulse meter

(N) Display unit

(O) Sensor controller

(P) Switching mode power supply

(Q) Stepper motor& Driver&Controller

(R) Graphic/Logic panel

(S) Field network device

(T) Software

(U) Other

TC Series

● TC4M

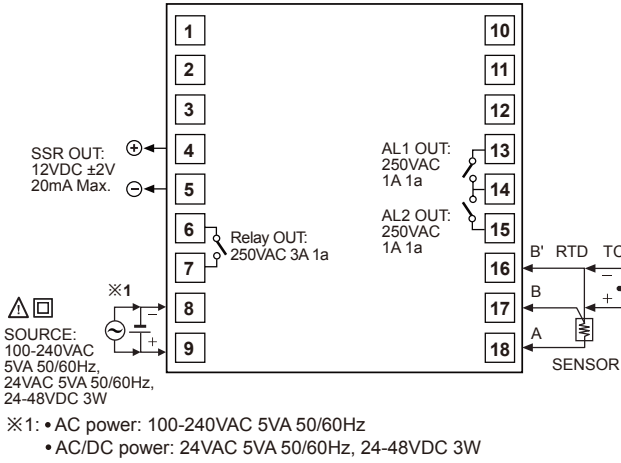

● TC4H/L

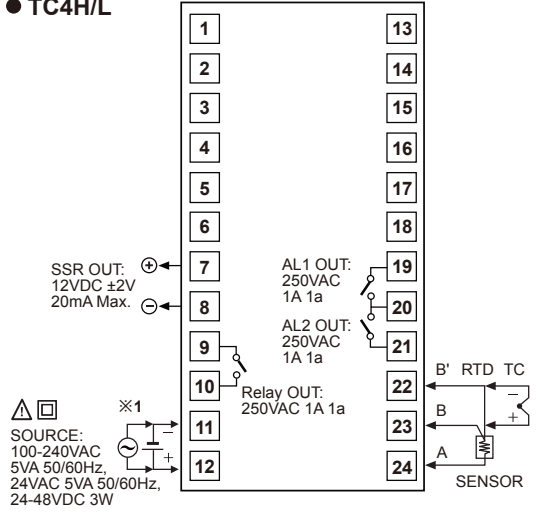

■ Dimensions

(unit: mm)

● TC4S

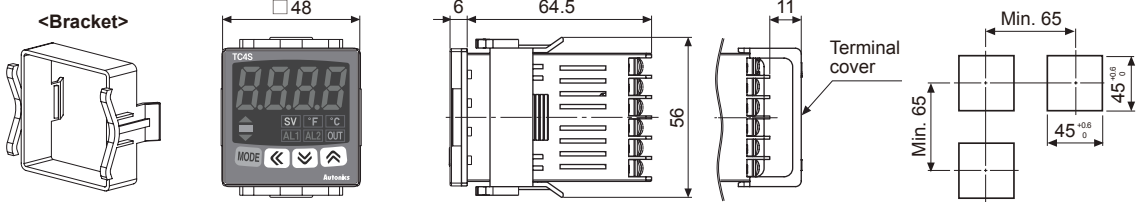

● TC4SP

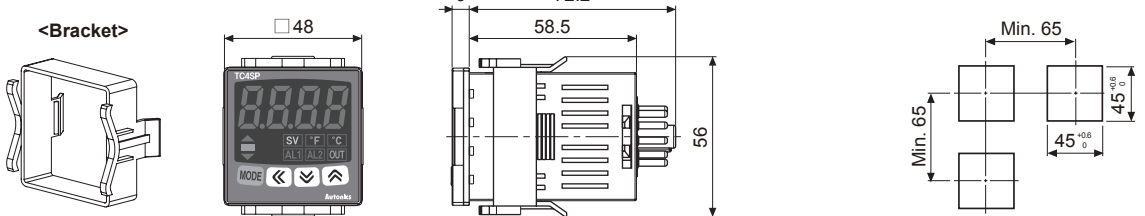

● TC4Y

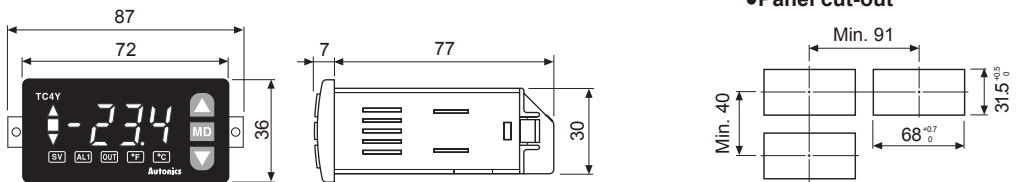

● TC4M

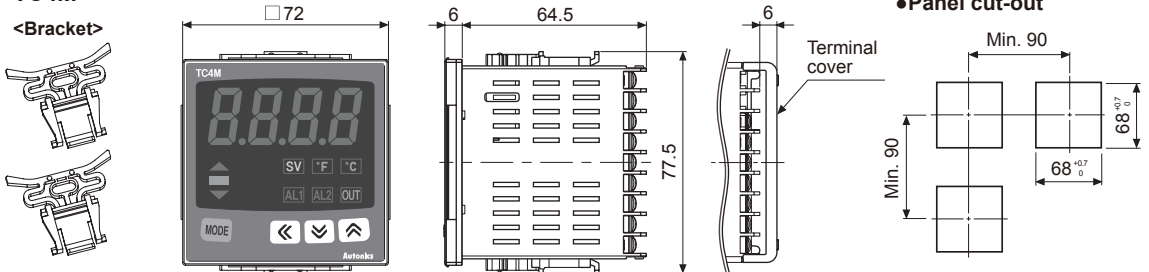

Economical PID Control

● TC4W

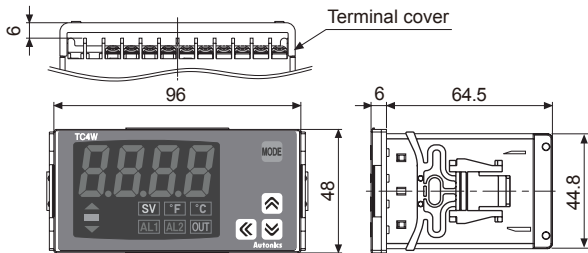
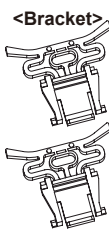

● Panel cut-out

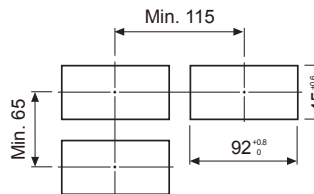

● TC4H

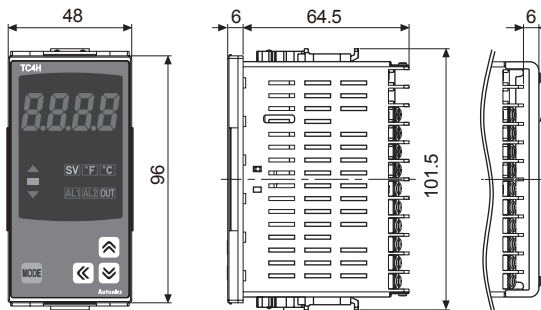
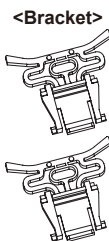

● Panel cut-out

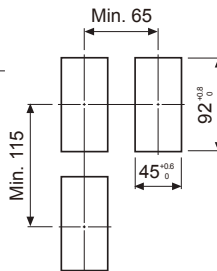

● TC4L

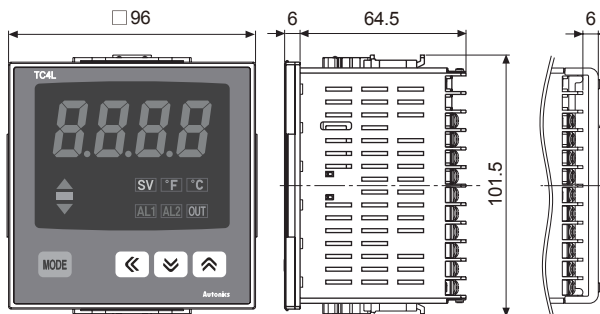
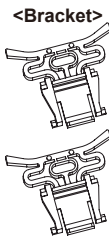

● Panel cut-out

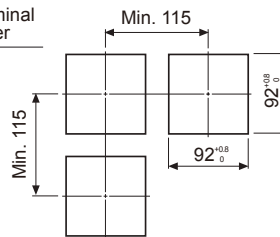

● Terminal cover(sold separately)

● RSA-COVER (48×48mm)

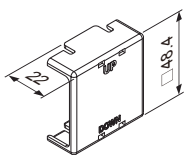

● RMA-COVER (72×72mm)

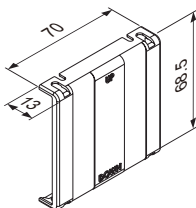

● RHA-COVER (48×96mm)

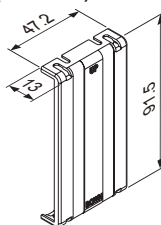

● RLA-COVER (96×96mm)

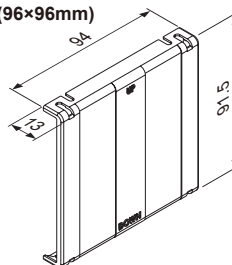

■ Product mounting

● TC4S/SP(48×48mm) Series

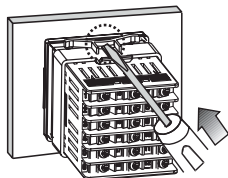

● TC4Y(72×36mm) Series

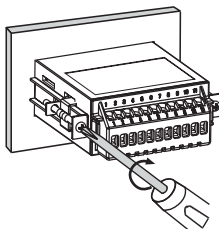

● Other Series

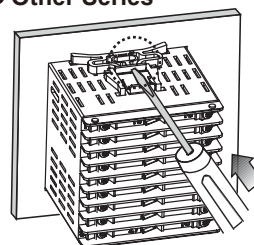

※Mount the product on the panel, fasten bracket by pushing with tools as shown above.
(In case of TC4Y, fasten bolts for bracket.)

(A) Photo electric sensor

(B) Fiber optic sensor

(C) Door/Area sensor

(D) Proximity sensor

(E) Pressure sensor

(F) Rotary encoder

(G) Connector/Socket

(H) Temp. controller

(I) SSR/ Power controller

(J) Counter

(K) Timer

(L) Panel meter

(M) Tacho/ Speed/ Pulse meter

(N) Display unit

(O) Sensor controller

(P) Switching mode power supply

(Q) Stepper motor& Driver&Controller

(R) Graphic/ Logic panel

(S) Field network device

(T) Software

(U) Other

TC Series

Parts description

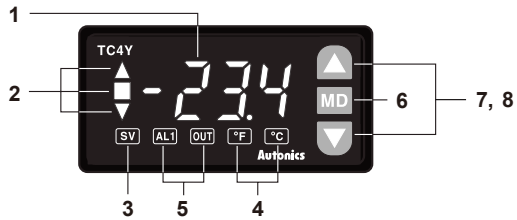
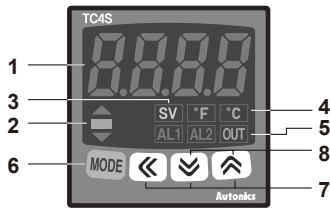

1. Present temperature (PV) display

- RUN mode: Present temperature (PV) display.
- Parameter setting mode: Parameter or parameter setting value display.

2. Deviation indicator, Auto-tuning indicator

It shows current temperature(PV) deviation based on set temperature(SV) by LED.

No	PV deviation temp.	Deviation display
1	Over 2°C	▲ lamp on
2	Below ±2°C	■ lamp on
3	Under -2°C	▼ lamp on

Deviation indicator (▲, ■, ▼) is flashed by every 1sec when operating auto tuning.

3. Set temperature(SV) indicator

Press any front key once to check or change current set temperature(SV), set temperature(SV) indicator is on and preset set value is flashed.

4. Temperature unit(°C/°F) indicator

It shows current temperature unit.

5. Control/alarm output indicator

- OUT: It will turn ON when control output(Main Control Output) is ON.

※In case of CYCLE/PHASE control of SSR drive output, it will turn ON when MV is over 3.0%. (only for AC voltage type)

- AL1/AL2: It will light up when alarm output Alarm1/Alarm2 are on.

6. [MODE] key

Used when entering into parameter setting group, returning to RUN mode, moving parameter, and saving setting values.

7. Adjustment

Used when entering into set value change mode, digit moving and digit up/down.

8. FUNCTION key

Press $\boxed{+}$ $\boxed{-}$ keys for 3 sec. to operate function(RUN/STOP, alarm output cancel) set in inner parameter [d1 - 2].

※Press $\boxed{+}$ $\boxed{-}$ keys at the same time in set value operation to move digit. (only for TC4Y Series)

Input type and range

Input sensor		Display	Input range (°C)	Input range (°F)
Thermocouple	K(CA)	℄CR	-50 to 1200	-58 to 2192
	J(IC)	℄I ℄	-30 to 500	-22 to 932
	L(IC)	℄I ℄	-40 to 800	-40 to 1472
RTD	DPT100Ω	dP℄H	-100 to 400	-148 to 752
		dP℄L	-100.0 to 400.0	-148.0 to 752.0
	Cu50Ω	℄US℄	-50 to 200	-58 to 392
		℄US℄	-50.0 to 200.0	-58.0 to 392.0

Factory default

● SV setting

Parameter	Factory default
-	0

● Parameter 1 group

Parameter	Factory default
RL1	1250
RL2	
℄℄	oFF
P	0 100
i	0000
d	0000
rES℄	0500
HYS	002

● Parameter 2 group

Parameter	Factory default	Parameter	Factory default
i n - ℄	℄CR	℄	0200
Uni ℄	°C	RL - 1	R℄1.R
i n - b	0000	RL - 2	R℄2.R
℄R℄F	000.1	℄HYS	000 1
L - Su	-050	LbAR℄	0000
H - Su	1200	LbARb	002
o - F℄	HER℄	d1 - ℄	5℄oP
℄ - ℄d	Pi d	Er℄u	0000
oU℄	rLY	L o ℄	oFF
SSr℄	5℄nd		

※AC/DC power type has no SSR drive output method selection [55r.℄] function and supports only ON/OFF output when selecting 55r in control output setting function [oU℄].

SV setting

※In case of changing set temperature from 210°C to 250°C.

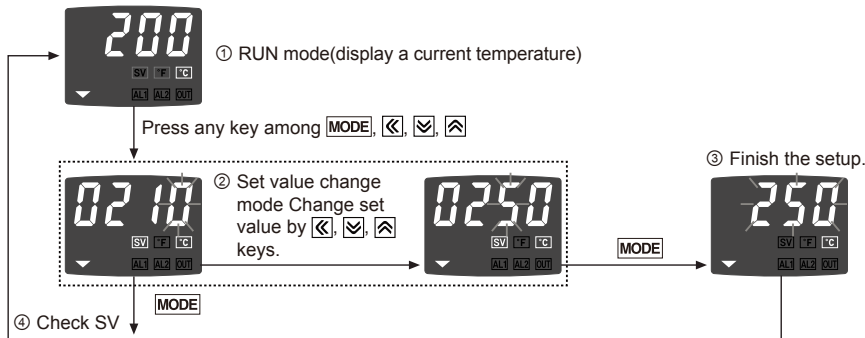

Flow chart for setting group

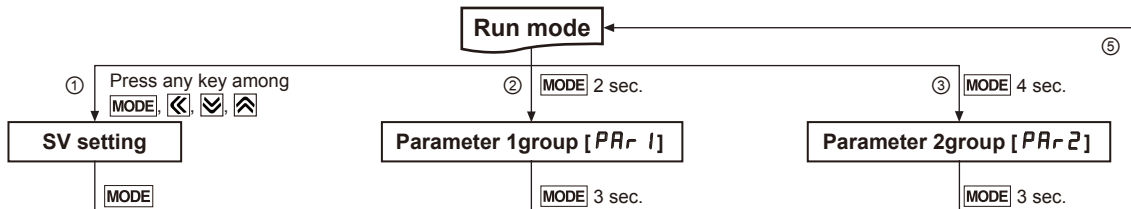

④

AL1	AL1 alarm temperature
AL2	AL2 alarm temperature
At	Auto tuning ON/OFF
P	Proportional band
I	Integral time
d	Derivative time
rSEt	Manual reset (Normal deviation correction)
HYS	ON/OFF control hysteresis

in-t	Input sensor
Unit	Temperature unit
in-b	Input correction
nAUF	Input digital filter
L-Su	SV low-limit value
H-Su	SV high-limit value
o-Ft	Control output operation
C-n	Control type
oUt	Control output type
SSr-n	SSR drive output method ^{※1}
t	Control cycle
AL-1	AL1 alarm operation mode
AL-2	AL2 alarm operation mode
AHYS	Alarm output hysteresis
LbAt	LBA monitoring time
LbAb	LBA detection range
dl-P	Digital key operation
Er-nu	Control output MV in case of input break error
LoC	Lock

※1: It is not displayed for AC/DC power type.

※If no key entered for 30 sec., it returns to RUN mode automatically and the set value of parameter is not be saved.

※: This parameter might not be displayed depending on other parameter settings.

① Press any key once in RUN mode, it advances to set value setting group.

② Press **MODE** key over 2sec. in RUN mode, it advances to setting group 1.

③ Press **MODE** key over 4sec. in RUN mode, it advances to setting group 2.

④ First parameter will be displayed on viewer when it advances to the setting group.

⑤ Press **MODE** key over 3sec. in the setting group, it returns to RUN mode.

※Exception: Press **MODE** key once in SV setting group it returns to RUN mode.

※Press **MODE** key again within a sec after return to RUN mode by press **MODE** key over 3sec., it advances to the first parameter of previous setting group.

※Parameter setup



- Set parameter as the above considering parameter relation of each setting group.
- Check parameter set value after change parameter of setting group 2.

※Indicator type displays shaded parameter(■) of setting group 2.

※AL-1, AL-2 parameter of setting group2 is decided whether to display according by alarm output type.

※If alarm operation mode[AL-1, AL-2] of setting group2 is set to AnOn / SbR□ / LbR□, AHYS parameter is not displayed.

(A)	Photo electric sensor
(B)	Fiber optic sensor
(C)	Door/Area sensor
(D)	Proximity sensor
(E)	Pressure sensor
(F)	Rotary encoder
(G)	Connector/Socket
(H)	Temp. controller
(I)	SSR/ Power controller
(J)	Counter
(K)	Timer
(L)	Panel meter
(M)	Tacho/ Speed/ Pulse meter
(N)	Display unit
(O)	Sensor controller
(P)	Switching mode power supply
(Q)	Stepper motor& Driver&Controller
(R)	Graphic/ Logic panel
(S)	Field network device
(T)	Software
(U)	Other

Parameter 1 group

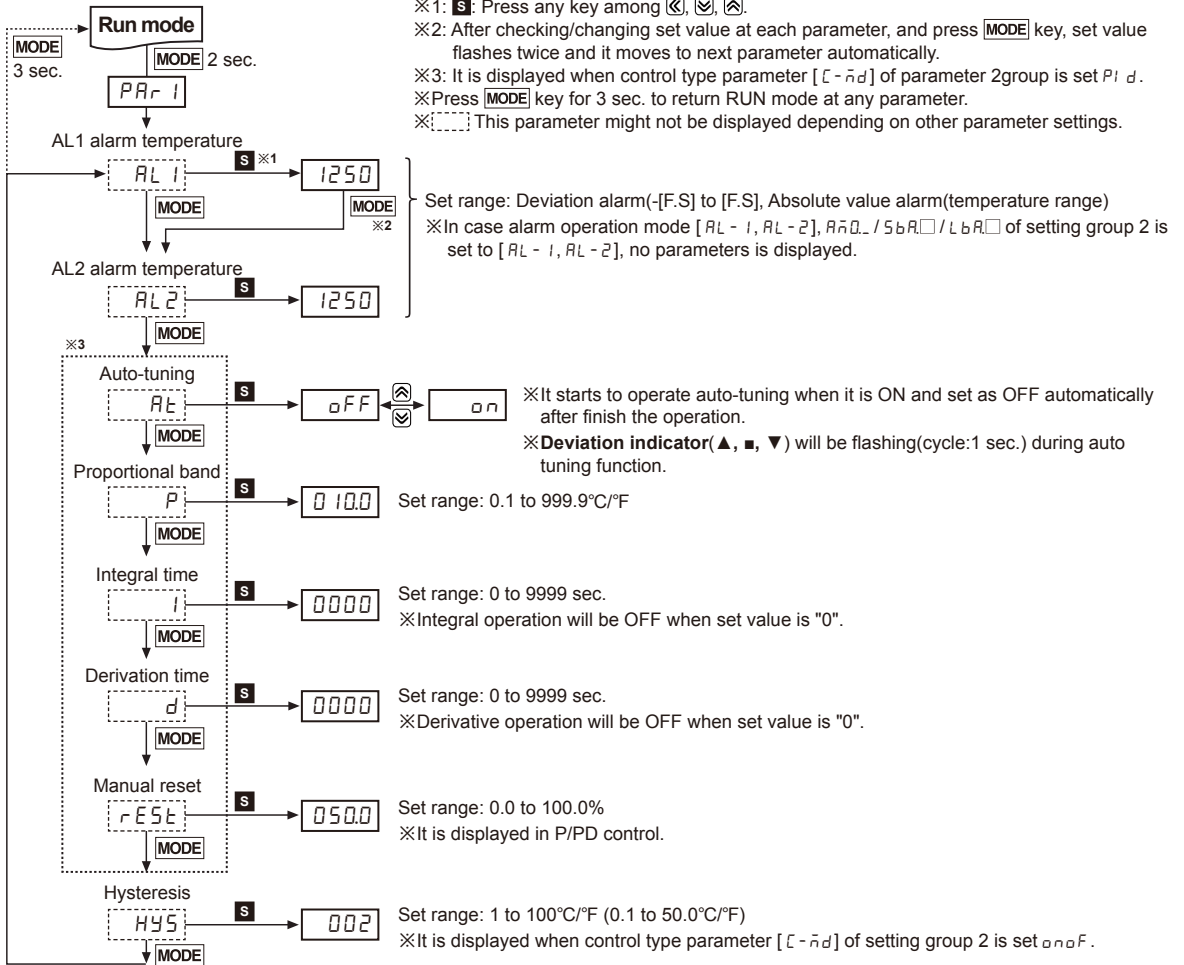

Parameter 2 group

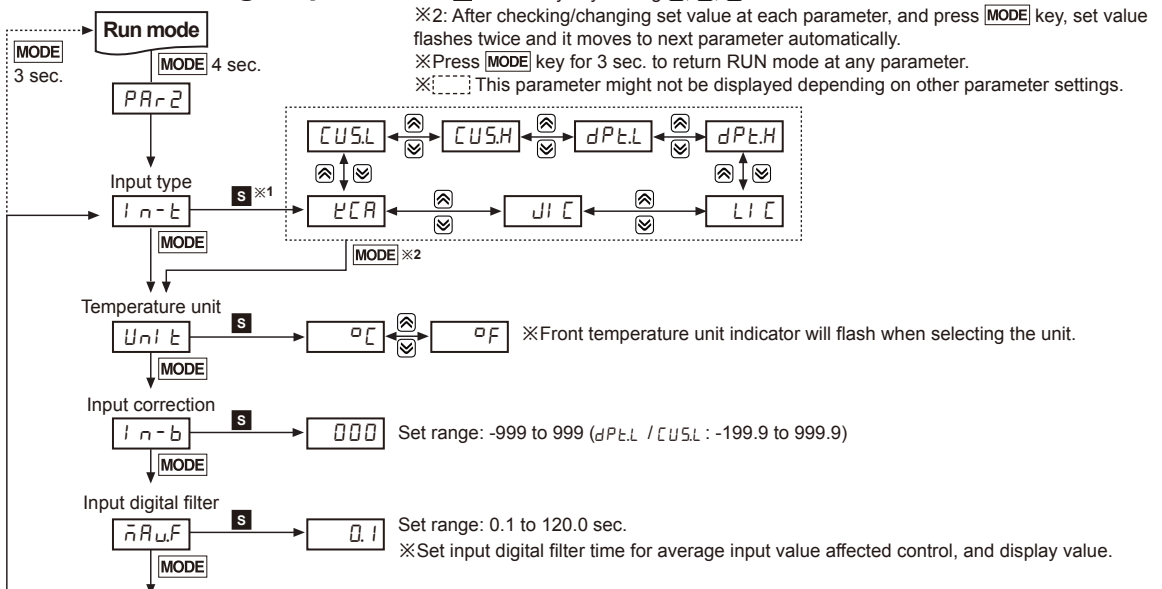

Economical PID Control

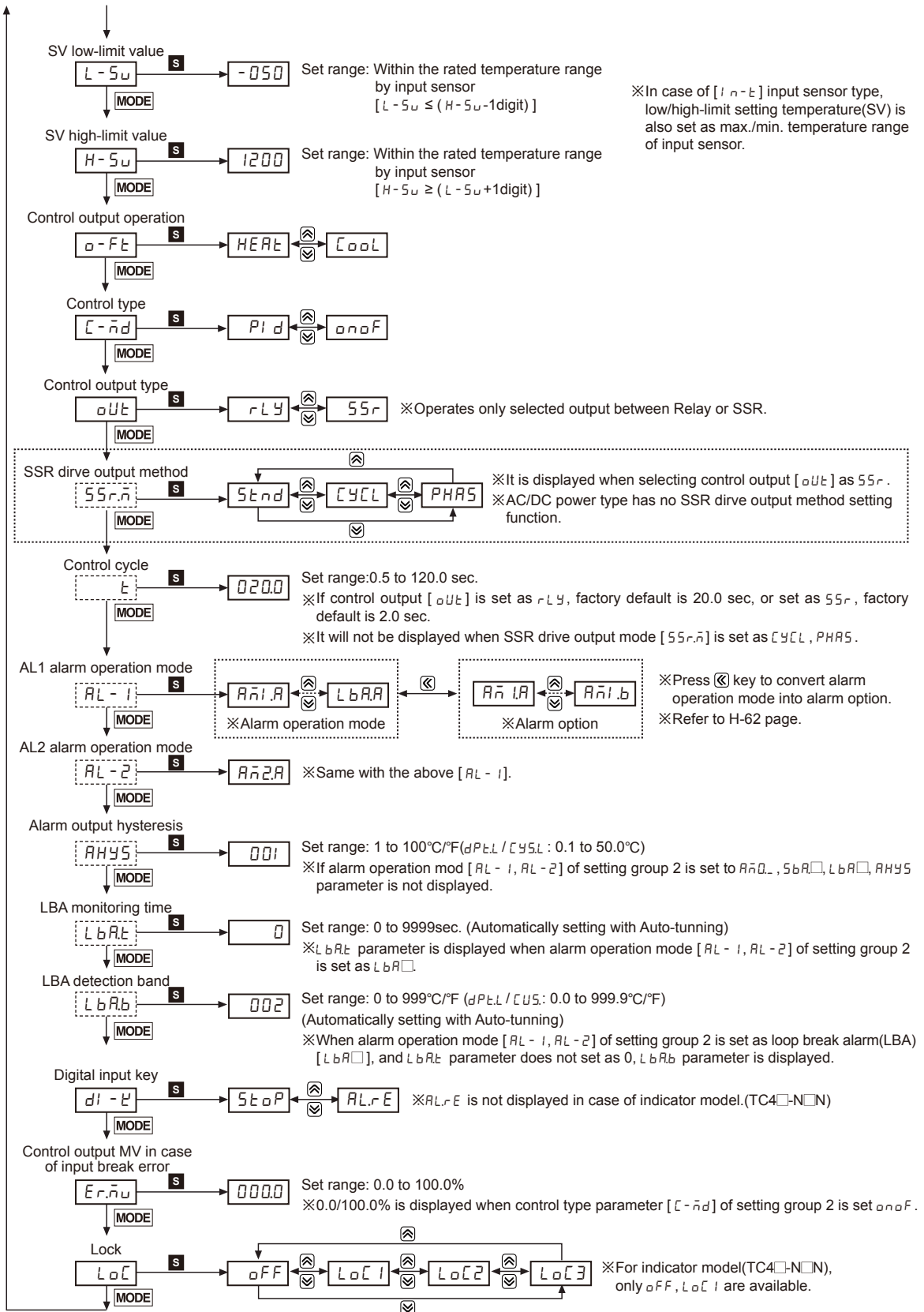

(A)	Photo electric sensor
(B)	Fiber optic sensor
(C)	Door/Area sensor
(D)	Proximity sensor
(E)	Pressure sensor
(F)	Rotary encoder
(G)	Connector/Socket
(H)	Temp. controller
(I)	SSR/ Power controller
(J)	Counter
(K)	Timer
(L)	Panel meter
(M)	Tacho/ Speed/ Pulse meter
(N)	Display unit
(O)	Sensor controller
(P)	Switching mode power supply
(Q)	Stepper motor& Driver&Controller
(R)	Graphic/ Logic panel
(S)	Field network device
(T)	Software
(U)	Other

TC Series

■ Functions

◎ Alarm [$AL - 1 / AL - 2$]

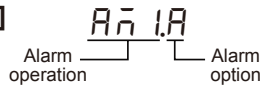

There are two alarms which operate individually. You can set combined alarm operation and alarm option. Use digital input key(set as $AL-E$) or turn OFF power and re-start this unit to release alarm operation.

● Alarm operation

Mode	Name	Alarm operation	Description
$R\bar{n}0$	—	—	No alarm output
$R\bar{n}1$	Deviation high-limit alarm		If deviation between PV and SV as high-limit is higher than set value of deviation temperature, the alarm output will be ON.
$R\bar{n}2$	Deviation low-limit alarm		If deviation between PV and SV as low-limit is higher than set value of deviation temperature, the alarm output will be ON.
$R\bar{n}3$	Deviation high/low-limit alarm		If deviation between PV and SV as high/low-limit is higher than set value of deviation temperature, the alarm output will be ON.
$R\bar{n}4$	Deviation high/low-limit reserve alarm		If deviation between PV and SV as high/low-limit is higher than set value of deviation temperature, the alarm output will be OFF.
$R\bar{n}5$	Absolute value high limit alarm		If PV is higher than the absolute value, the output will be ON.
$R\bar{n}6$	Absolute value low limit alarm		If PV is lower than the absolute value, the output will be ON.
$5bR$	Sensor break Alarm	—	It will be ON when it detects sensor disconnection.
LbR	Loop break Alarm	—	It will be ON when it detects loop break.

※ H: Alarm output hysteresis [$RH5$]

● Alarm option

Mode	Name	Description
$R\bar{n}A$	Standard alarm	If it is an alarm condition, alarm output is ON. If it is a clear alarm condition, alarm output is OFF.
$R\bar{n}b$	Alarm latch	If it is an alarm condition, alarm output is ON and maintains ON status.
$R\bar{n}c$	Standby sequence1	First alarm condition is ignored and from second alarm condition, standard alarm operates. When power is supplied and it is an alarm condition, this first alarm condition is ignored and from the second alarm condition, standard alarm operates.
$R\bar{n}d$	Alarm latch and standby sequence1	If it is an alarm condition, it operates both alarm latch and standby sequence. When power is supplied and it is an alarm condition, this first alarm condition is ignored and from the second alarm condition, alarm latch operates.
$R\bar{n}e$	Standby sequence2	First alarm condition is ignored and from second alarm condition, standard alarm operates. When re-applied standby sequence and if it is alarm condition, alarm output does not turn ON. After clearing alarm condition, standard alarm operates.
$R\bar{n}f$	Alarm latch and standby sequence2	Basic operation is same as alarm latch and standby sequence1. It operates not only by power ON/OFF, but also alarm setting value, or alarm option changing. When re-applied standby sequence and if it is alarm condition, alarm output does not turn ON. After clearing alarm condition, alarm latch operates.

※ Condition of re-applied standby sequence for standby sequence 1, alarm latch and standby sequence 1: Power ON
 Condition of re-applied standby sequence for standby sequence 2, alarm latch and standby sequence 2: Power ON, changing set temperature, alarm temperature [$AL 1, AL 2$] or alarm operation [$AL - 1, AL - 2$], switching STOP mode to RUN mode.

◎ Sensor break alarm

The function that alarm output will be ON when sensor is not connected or when sensor's disconnection is detected during temperature controlling. You can check whether the sensor is connected with buzzer or other units using alarm output contact. It is selectable between standard alarm [$5bR$], or alarm latch [$5bRb$].

◎ Loop break alarm(LBA)

It checks control loop and outputs alarm by temperature change of the subject. For heating control(cooling control), when control output MV is 100%(0% for cooling control) and PV is not increased over than LBA detection band [$LbRb$] during LBA monitoring time [$LbRt$], or when control output MV is 0%(100% for cooling control) and PV is not decreased below than LBA detection band [$LbRb$] during LBA monitoring time [$LbRt$], alarm output turns ON.

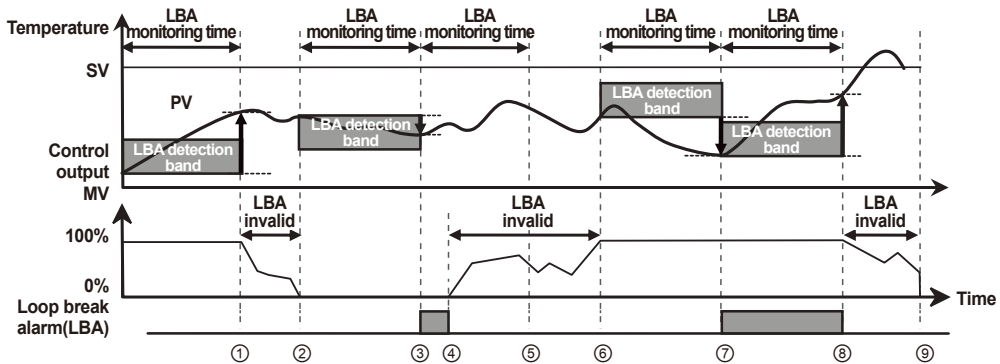

Start control to ①	When control output MV is 0% and PV is not decreased below than LBA detection band [$LbRb$] during LBA monitoring time [$LbRt$]
① to ②	The status of changing control output MV (LBA monitoring time is reset.)
② to ③	When control output MV is 0% and PV is not decreased below than LBA detection band [$LbRb$] during LBA monitoring time [$LbRt$] loop break alarm (LBA) turns ON after LBA monitoring time.
③ to ④	Control output MV is 0% and loop break alarm (LBA) turns and maintains ON.
④ to ⑥	The status of changing control output MV (LBA monitoring time is reset.)
⑥ to ⑦	When control output MV is 100% and PV is not increased over than LBA detection band [$LbRb$] during LBA monitoring time [$LbRt$], loop break alarm (LBA) turns ON after LBA monitoring time.
⑦ to ⑧	When control output MV is 100% and PV is increased over than LBA detection band [$LbRb$] during LBA monitoring time [$LbRt$] loop break alarm (LBA) turns OFF after LBA monitoring time.
⑧ to ⑨	The status of changing control output MV (LBA monitoring time is reset.)

※When executing auto-tuning, LBA detection band[$LbRb$] and LBA monitoring time are automatically set based on auto tuning value. When alarm operation mode [$AL-1, AL-2$] is set as loop break alarm(LBA)[$LbR□$], LBA detection band [$LbRb$] and LBA monitoring time [$LbRt$] parameter is displayed.

◎ SSR drive output function(SSRP function) [$55r.n$]

- Realizing high accuracy and cost effective temperature control with both current output (4-20mA) and linear output(cycle control and phase control)
- SSRP output is selectable one of standard ON/OFF control, cycle control, phase control by utilizing standard SSR drive voltage output.
- Select one of standard ON/OFF control [$5tnd$], cycle control[$LYCL$], phase control[$PHRS$] at $55r.n$ parameter of setting 2 group. For cycle control, connect zero cross turn-on SSR (random turn-on SSR is also available). For phase control, connect random turn-on SSR.

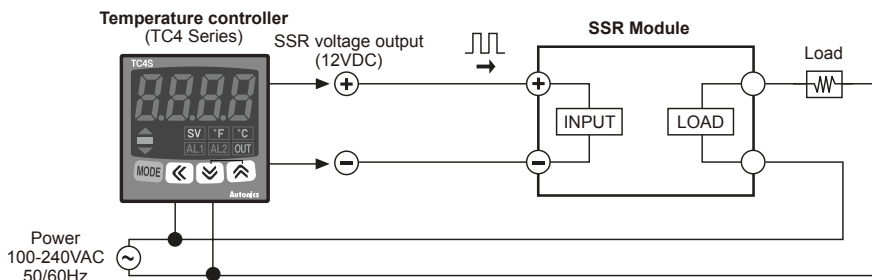

※When selecting phase or cycle control mode, the power supply for load and temperature controller must be the same.

※In case of selecting PID control type and phase [$PHRS$] / cycle [$LYCL$] control output modes, control cycle [t] is not allowed to set.

※For AC/DC power model (TC4□-□2R), this parameter is not displayed and it is available only standard control by relay or SSR.

(A)	Photo electric sensor
(B)	Fiber optic sensor
(C)	Door/Area sensor
(D)	Proximity sensor
(E)	Pressure sensor
(F)	Rotary encoder
(G)	Connector/Socket
(H)	Temp. controller
(I)	SSR/Power controller
(J)	Counter
(K)	Timer
(L)	Panel meter
(M)	Tacho/Speed/ Pulse meter
(N)	Display unit
(O)	Sensor controller
(P)	Switching mode power supply
(Q)	Stepper motor& Driver&Controller
(R)	Graphic/Logic panel
(S)	Field network device
(T)	Software
(U)	Other

● Standard ON/OFF control mode [5tnd]

A mode to control the load in the same way as Relay output type.
(ON: output level 100%, OFF: output level 0%)

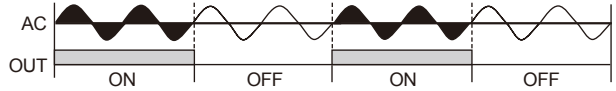

● Cycle control mode [CYCL]

A mode to control the load by repeating output ON / OFF according to the rate of output within setting cycle.
Having improved ON / OFF noise feature by Zero Cross type.

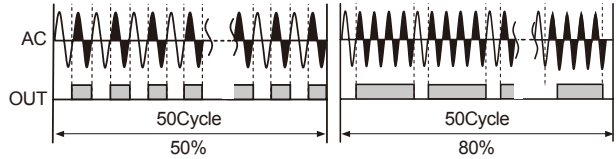

● Phase control mode [PHAS]

A mode to control the load by controlling the phase within AC half cycle. Serial control is available.
RANDOM Turn-on type SSR must be used for this mode.

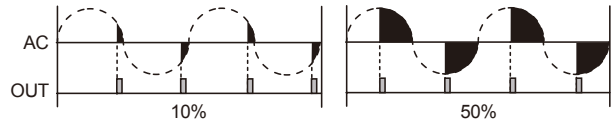

◎ Auto tuning [At]

- When setting At parameter to ON, front temperature unit display(°C or °F) lamp will be flickering during Auto tuning. After completing auto tuning, temperature unit display lamp returns to normal operation and At parameter automatically becomes [ON → OFF].
- Set as OFF to stop auto tuning.
※It keeps previous P, I, D set values.
- If SV is changed during auto tuning mode, auto tuning is stopped.
- PID time constants figured out through auto tuning function can be changed.
- If control method[CL-nd] is set to ONOFF, no parameters are displayed.
- Finish auto tuning when [OPEN] error occurs during the operation.
※In case of [OPEN] error, auto tuning operation is not applicable.

◎ Input correction [In-b]

- Input correction is to correct deviation occurred from temperature sensor such as thermocouples, RTD etc. If you check the deviation of every temperature sensor precisely, it can measure temperature accurately.
- Use this mode after measuring deviation occurred from temperature sensor exactly. Because if measured deviation value is not corrected, displayed temperature may be too high or too low.
- When you set the Input revise value, you may need to record it, because it will be useful when performing maintenance.

◎ Input digital filter [nAF]

A function to filter input signals for more stable PV display in order to provide stable control output. If noise occurs on input signals or PV value keeps changing, it gets difficult to perform high accuracy control since PV has a direct effect on output level.

◎ Control method selection [CL-nd]

It is selectable PID, ON/OFF control.

- In case of ON/OFF [ONOFF] mode, Hysteresis [HY5] parameter is displayed.
- In case of PID [PID] mode, Proportional band [P], Integral time [I], and Derivative time [D] parameters are displayed.

◎ Hysteresis [HY5]

- Set control output ON / OFF interval in ON / OFF control mode.

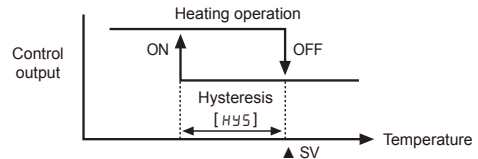

- If Hysteresis is too narrow, hunting(oscillation, chattering) could occur due to external noise.
- In case of ON / OFF control mode, even if PV reaches stable status, there still occurs hunting. It could be due to Hysteresis [HY5] SV, load's response characteristics or sensor's location. In order to reduce hunting to a minimum, it is required to take into following factors consideration when designing temp. controlling; proper Hysteresis [HY5], heater's capacity, thermal characteristics, sensor's response and location.

◎ Temperature unit selection [Un t]

- A function to select display temperature unit
- Unit display lamp will be ON when converting temperature unit

◎ Manual reset [rE5t]

When selecting P/PD control mode, certain temperature difference exists even after PV reaches stable status because heater's rising and falling time is inconsistent due to thermal characteristics of controlled objects, such as heat capacity, heater capacity. This temperature difference is called offset and manual reset [rE5t] function is to set/correct offset.

- When PV and SV are equal, reset value is 50.0%. After control is stable, PV is lower than SV, reset value is over 50.0% or PV is higher than SV, reset value is below 50.0%.
- Manual reset [rE5t] by control result

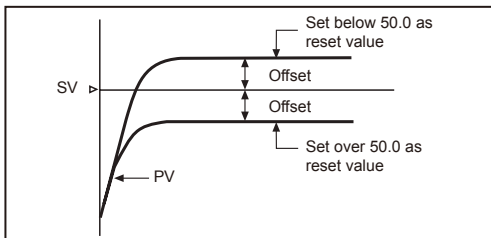

✕Manual reset function is applicable only to P / PD control mode.

◎ Cool / Heat function [oFt]

Generally there are two ways to control temperature, one (Heat-function) is to heat when PV is getting down(Heater). The other(Cool-function) is to cool when PV is getting higher (Freezer).

These functions are operating oppositely when it is ON/OFF control or proportional control. But in this case PID time constant will be different due to PID time constant will be decided according to control system when it is PID control.

- Cool-function [COOL] and heat-function [HEAT] must be set correctly according to the application, if set as opposite function, it may cause a fire. (If set cool-function [COOL] at heater, it will be maintained ON and it may cause a fire.)
- Avoid changing heat-function to cool-function or cool-function to heat-function when the unit is operating.
- It is impossible to operate both function at once in this unit. Therefore, only one function should be selected only.

◎ SV High/Low limit [L-5u / H-5u]

- It sets SV high/low limit Limit range of using temperature within temperature range for each sensor, user can set/change set temperature(SV) within SV high limit [H-5u] to SV low limit [L-5u]. (✕ L-5u > H-5u cannot be set.)
- When changing input type [In-t], SV high limit [H-5u] and SV low limit [L-5u] of using temperature will be initialized as max./min.value of sensor temperature range automatically.

◎ Digital input key(☑ + ☒ 3sec.) [dl - t]

Press ☑+☒ keys for 3 sec. at the same time and it operates RUN/STOP function[5tOP] which is set at dl - t or alarm clear function[RLrE].

■ RUN/STOP function [5tOP]

It is allowed for users to select RUN / STOP in RUN mode.

- When it is required to stop control output temporarily (e.g., during maintenance work), use 5tOP command to stop control output.(auxiliary output is normally provided as setting values.)
- In case of STOP mode, 5tOP parameter and PV value is flashing in turn on display part.
- When power is off in 'STOP' mode, 'STOP' mode will be kept after Power is supplied again. (in order to return to normal control operation, make 'STOP' mode OFF using front keys.)

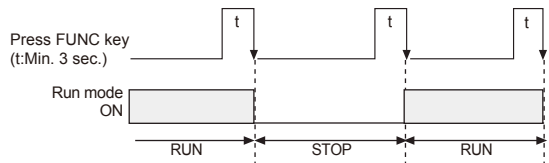

■ Alarm reset [RLrE]

A function to reset or initialize alarm output by force while alarm output is ON. Applicable only to Alarm latch [Rn□b] and Alarm latch and standby sequence[Rn□d] mode.

✕If PV value is within alarm output range, this function is not available.

◎ Lock setting [LoC]

A function to prevent changing SV and parameters of each setting group. Parameter setting values are still possible to check while Lock mode is ON.

Display	Description
oFF	Lock off
L o C 1	Lock parameter group 2
L o C 2	Lock parameter group 1, 2
L o C 3	Lock parameter group 1, 2, SV setting

✕ oFF, L o C 1 are available only for indicator(TC4□N□N).

◎ Error

Display	Description	Troubleshooting
oPE n	Flashes if input sensor is disconnected or sensor is not connected.	Check input sensor state.
HHHH	Flashes if measured sensor input is higher than temperature range.	When input is within the rated temperature range, this display disappears.
LLLL	Flashes if measured sensor input is lower than temperature range.	

(A) Photo electric sensor

(B) Fiber optic sensor

(C) Door/Area sensor

(D) Proximity sensor

(E) Pressure sensor

(F) Rotary encoder

(G) Connector/Socket

(H) Temp. controller

(I) SSR/Power controller

(J) Counter

(K) Timer

(L) Panel meter

(M) Tacho/Speed/Pulse meter

(N) Display unit

(O) Sensor controller

(P) Switching mode power supply

(Q) Stepper motor& Driver&Controller

(R) Graphic/Logic panel

(S) Field network device

(T) Software

(U) Other

TC Series

◎ Output connections

See H-139 page for output.

● Application of relay output type

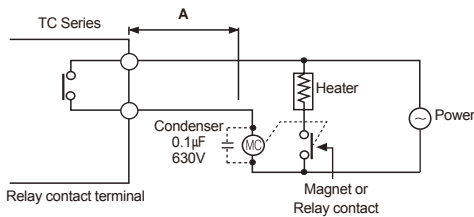

Keep **A** length as long as possible when wiring the temperature controller and the load. If wire length of **A** is short, counter electromotive force which occurs from a coil of magnet switch & power relay may flow in power line of the unit, and it may cause malfunction.

If wire length of **A** is short, please connect mylar condensers 104(630V) on the both ends of "MC" (magnet coil) to protect electromotive force.

● Application of SSR drive output method

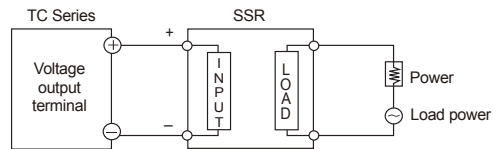

- ※SSR should be selected by the capacity of load, otherwise, it may short-circuit and result in a fire. Indirect heated should be used with SSR for efficient working.
- ※Please use a cooling plate or it may cause the capability deterioration, breakdown of SSR for a long usage.
- ※Refer to the H-63 page for phase/cycle control connections.

■ Proper usage

◎ Simple "error" diagnosis

● When the load (Heater etc) is not operated

Please check operation of the OUT lamp located in front panel of the unit.

If the OUT lamp does not operate, please check the parameter of all programmed mode.

If lamp is operating, please check the output(Relay, SSR drive voltage) after separating output line from the unit.

● When it displays $\square PE n$ during operation

This is a warning that external sensor is open. Please turn off the power and check the wire state of the sensor. If sensor is not open disconnect sensor line from the unit and short the input +, - terminal. Turn on the power of the unit and check the controller displays room temperature.

If this unit cannot display room temperature, this unit is broken. Please remove this unit and contact our service center. (When the input mode is thermocouple, it is available to display room temperature.)

◎ Caution for using

- The connection wire of this unit should be separated from the power line and high voltage line in order to prevent from inductive noise.
- For crimp terminal, select following shaped terminal (M3)

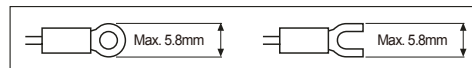

- Please install power switch or circuit-breaker in order to cut power supply off.
- The switch or circuit-breaker should be installed near by users.
- This unit is designed for temperature controlling only. Do not apply this unit as a voltage meter or a current meter.
- In case of using RTD sensor, 3-wire type must be used. If you need to extend the line, 3-wires must be used with the same thickness as the line. It might cause temperature difference if the resistance of line is different.
- In case of making power line and input signal line close, line filter for noise protection should be installed at power line and input signal line should be shielded.
- Keep away from the high frequency instruments.(High frequency welding machine & sewing machine, big capacitive SCR controller)
- When supplying measured input, if HHHH or LLLL is displayed, measured input may have problem. Turn off the power and check the line.
- Installation environment
 - It shall be used indoor.
 - Altitude Max. 2000m.
 - Pollution Degree 2
 - Installation Category II.